

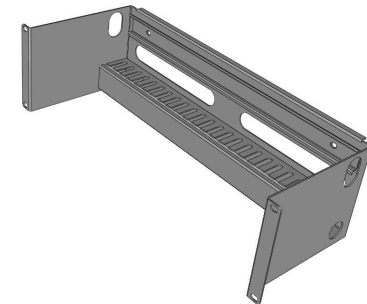

Type	Name	Description	Qty
------	------	-------------	-----

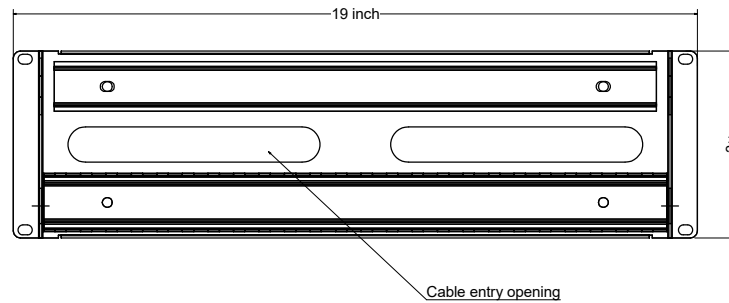
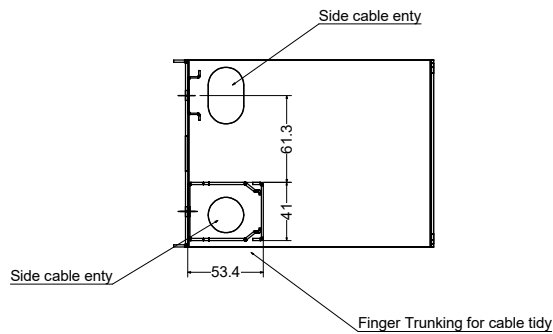
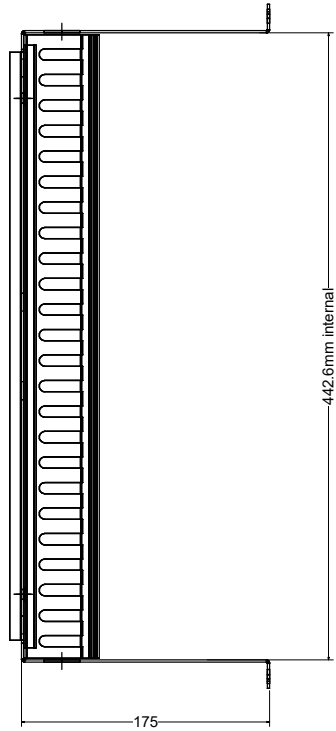

Description.	3u 19" Rack Mount DIN Rail Panel Bracket		Material.	Designed by Shane	Customer AD-TEK
			1.5 Mild Steel	Date	
Drawing No.	Rev.	Scale	Finish	Tolerance	 Units 31-37, Broton Drive, Broton Industrial Estate, Halstead. Essex. CO9 1HB Telephone : 01787 474470 e-mail : sales@ad-tekproducts.co.uk
3UDIN	0	1 : 1		+ / - 0.2mm	

All rights strictly reserved reproduction or issue to third parties in any form whatsoever is NOT permitted without written consent from Ad-Tek Products